

RoHS

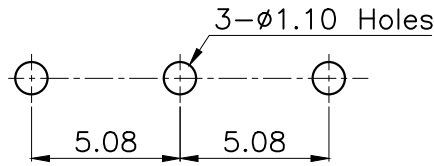

PCB Layout (Pattern side)

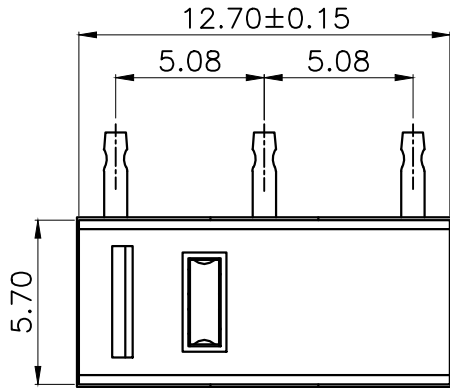
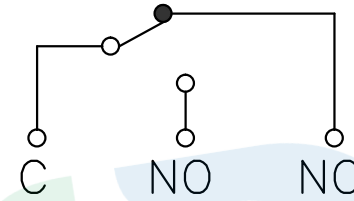

Circuit Diagram

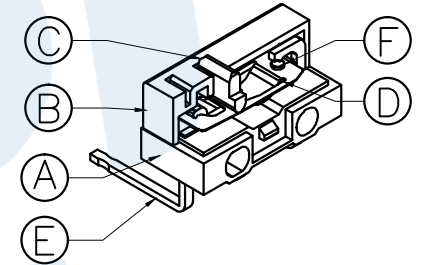
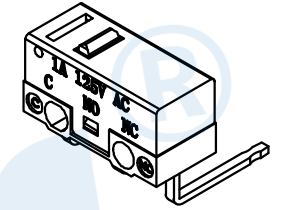

Operating force
80±15gf

Contact material	
CODE	MATERIAL
T	Copper dot
Y	Silver dot

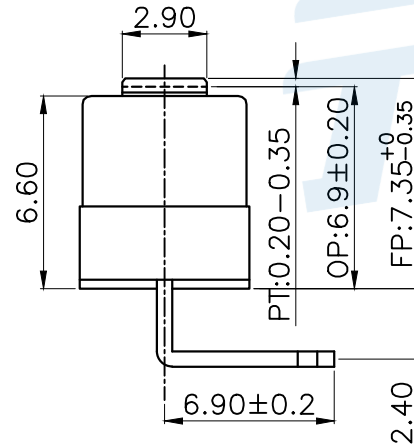
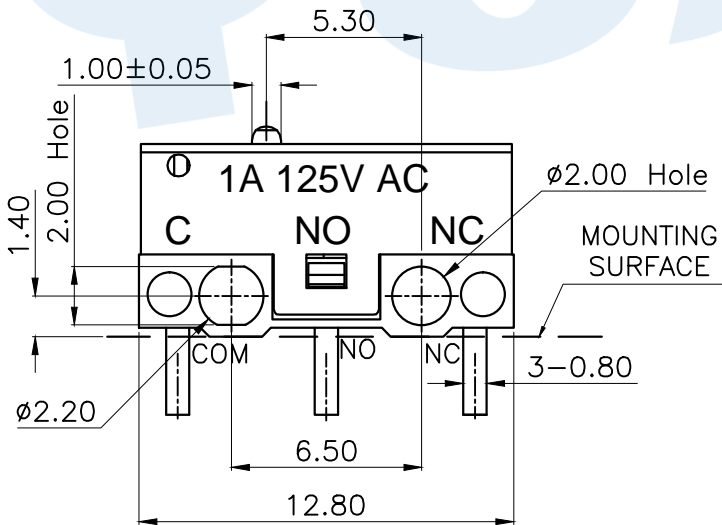

ⓕ	Contact	1	Silver/copper dot		
ⓔ	Terminal	3	Brass	Silver	
ⓓ	Contact reed	1	Brass		
Ⓒ	Handle	1	POM	White	
Ⓑ	Cover	1	PBT	Black	
Ⓐ	Base	1	PBT	White	
NO.	Name	Number	Qty	Material	Remarks

YUANDI® Yuandi Electronics Co., Ltd

design	date	name	MICRO SWITCH
Review	date	model	TC-5610A8-□
Approved	date		

Drawing number: Proportion 1:1 unit mm gage number A4

modify Review Approved Tolerance not specified

angle	±2'
10~30	±0.30
5~10	±0.20
~ 5	±0.10