

RoHS

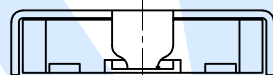
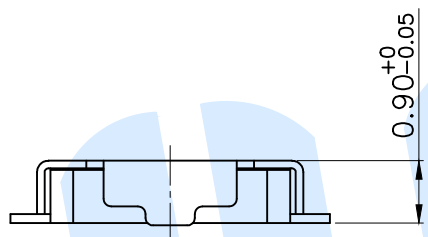
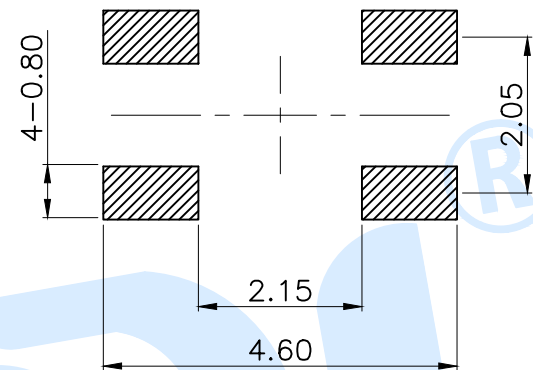
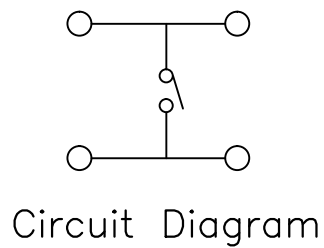
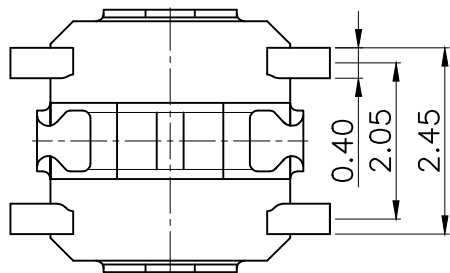

PCB Layout(Pattern side)

SHRAPNEL	
CODE	MATERIAL/QTY
D2	SUS/1PCS
D4	SUS/2PCS

OPERATING FORCE	
CODE	VIGOR
B2	180±30gf
B3	250±30gf

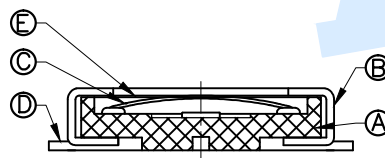
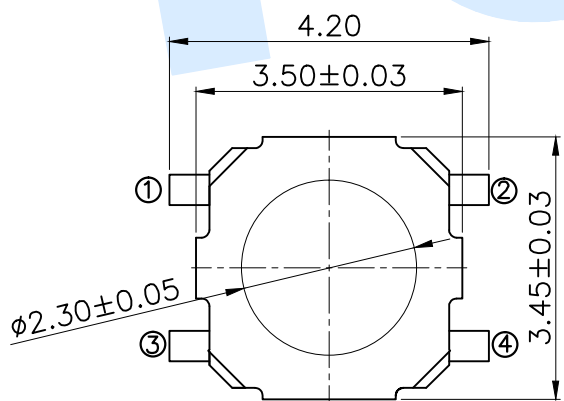

NO.	Name	Number	Qty	Materil	Remarks
⑤	Dust film	/	1	Polyimide tape	
④	Terminal	/	4	Phosphor Copper	Silvering
③	Reed	/	2	SUS	Silver covered
②	Cover	/	1	SUS	Natural
①	Base	/	1	LCP	Black

**YUANDI®** Yuandi Electronics Co, Ltd

design	date	name	TACT SWITCHS
Review	date	model	TS-1075A-B□D□
Approved	date		

Drawing number: Proportion 1:1 unit mm gage number A4

modify Review Approved Tolerance not specified

angle	±2'
10~30	±0.30
5~10	±0.20
~ 5	±0.10